

Model H3,H4,H5

Bi-metal type, Single-Pole Single-Throw (SPST), Non-adjustable, Snap action, Open on temperature-rise, Single operation thermostat

Features

- Ultra high-speed response single operation thermostat
- Calibration temperature range is from 130°C to 260°C
- Calibration temperature tolerance is possible from $\pm 3^\circ\text{C}$ to $\pm 10^\circ\text{C}$
(Please consult us in case tolerance less than $\pm 3^\circ\text{C}$)
- Reset temperature is less than -35°C . This prevents the thermostat from resetting under normal operating condition.
- Available with exposed bi-metallic elements for even faster thermal response.
- Heat resistant resin case is able to isolate devices from the electrical circuit.
- Custom terminals and mounting of lead wires are available.

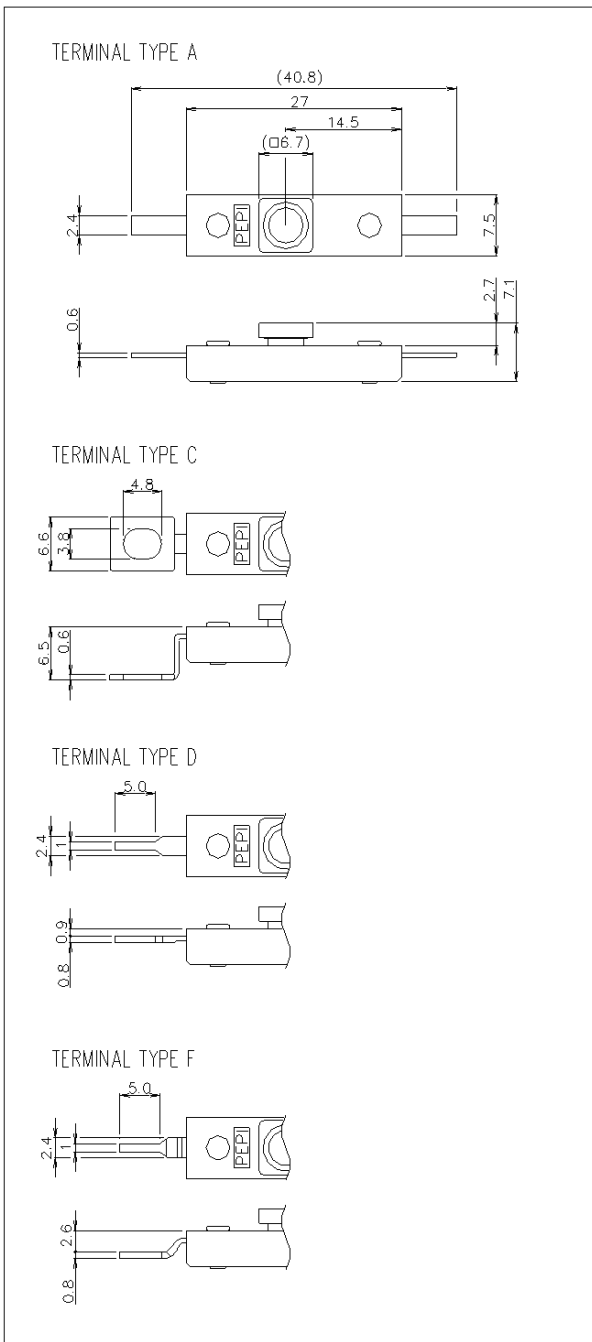

Electrical Contact Ratings

Model	Electrical ratings
H3	250Vac 10A Max resistive load
H4	50Vdc 0.5A Max resistive load
H5	250Vac 15A Max resistive load

Calibration Temperature Range

130°C~260°C

Applications

Home appliances, Kitchen appliances, Haircare products, Office automation equipment (laser printers, fax machines, copy machines, etc.), and over temperature protection of heaters in general industries.

Certifications

UL/c-UL, TUV

We come through when the heat is on®